

Ex d approved Smart IoT Gateway - Ex d iConnector



Smart City, Smart Agriculture, Smart Facility, Smart Factory, Smart Utility, Smart Energy, Smart Logistic

SKU: STHC-X

ZONE 1/2 EXPLOSION-PROOF IOT GATEWAY Ex d iConnector STHC-X



STHC-X WITH INTEGRATED WIRELESS BRIDGE/CO-ORDINATOR

STHC-X-H1.PNG



Safe Zone

Hazardous Zones

STHC-X is a Smart IoT Gateway, aka iConnector, with Ex d approved by ATEX, a main component in any IoT application. iConnector has a role to connect the real World's things like sensors, meters, machines...to server system for data logging, data analytics, monitoring & controls...iConnector support multiple Industrial Fieldbus like Modbus, EthernetIP, Profinet, CCLink, Wireless sensor network...It connects to server system via LAN/WAN as Ethernet, WiFi or Cellular. STHC-X can be installed in Zone 1 or Zone 2.

Applications

Condition Based Monitoring, Energy Monitoring, Facility Monitoring, Fuel Monitoring, Gas Leakage Detection, Machine Health Monitoring, Production Monitoring, Temperature Monitoring, Vibration Monitoring, Warehouse Monitoring, Water Meter Reading

Notes For Applications

- 3-in-1 Device**
iConnector is a 3-in-1 device, comprises Data logger + Logic Controller + Internet Gateway
- NO need Programming**
Don't need to learn any Programming language, just configure it remotely by Globiots platform
- Just 2-step for using**
Just install and configure it remotely on Globiots, then you can start use it!
- Multiple Fieldbus Protocols**
Support multiple Fieldbus protocols like Modbus, EthernetIP, Profinet, CCink...

IOT SOLUTIONS BY CONNECTING TO GLOBIOTS PLATFORM or ANY IOT PLATFORM

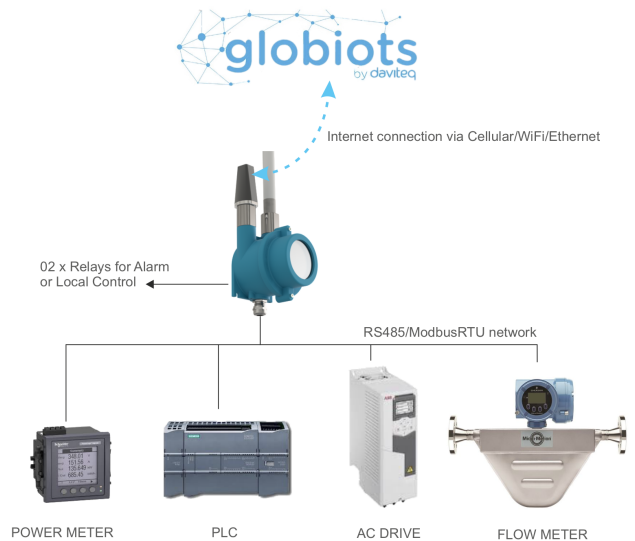

STHC-X-H2.PNG

DAVITEQ TECHNOLOGIES INC

Ho Chi Minh City, VN | Koblenz, DE | Melbourne, AU | Zurich, CH

+84.28.6268.2523 / 6268.2524

info@daviteq.com

www.iot.daviteq.com

Created date: Jul-03-2024

Updated date: Nov-04-2024

1/4

Specification

Host Communication Cellular type	GPRS Quadband (850/900/1800/1900)/3G-Dual band (2100/900)/3G- Penta Band (2100/1900/850/850Japan/900/800Japan), external antenna
Host Communication Ethernet type	01 x RJ45 port, 10Mbps
Host Communication WiFi type	802.11b/g/n, 2.4Ghz, external antenna
Host communication supports	TCP/IP, UDP/IP, FTP, HTTPS, SNMP, MQTT...
Fieldbus communication	ModbusRTU x 01 port, 31 slaves, max 19.2 kpbs
Wireless connections	Optional built-in wireless bridge or wireless co-ordinator
Vietnam Type Approval Certification	QCVN 54:2011/BTTTT, QCVN 15:2015/BTTTT (DAVITEQ B00122019)
ATEX Certification	IMQ 14 ATEX 005 X and TÜV CY 18 ATEX 0206158 X
Marking	ATEX II 2G Ex db IIC T5/T6 Gb and ATEX II 2D Ex tb IIIC T100/T85°C Db
Directive	ATEX 2014/34/EU
Standards	IEC-EN60079-0 IEC-EN60079-1 IEC-EN60079-31
Applicable Zones	Zone 1 - 21 (gas) and Zone 2 - 22 (dust)
Power supply	7..48VDC, avg 200mA, peak 2.0A with back-up Lithium Super Capacitor
On-board logging	2MB Flash
Electrical connection	01xM25 conduit (cable gland is not included)
SIM slot	01 x micro-SIM (cellular versions only)
Relay outputs	02 x relay SPST NO contact, 125VAC@0.3A or 24VDC@1A
Mounting method	Wall mount
Operating ambient Temperature	-40 .. + 85oC
Housing/Protection	Cast Aluminum with powder coating and glass windows, IP66
Dimension / Net weight	H120xW120xD120 (not included antenna) / 1.7 kgs

DAVITEQ TECHNOLOGIES INC

 Ho Chi Minh City, VN | Koblenz, DE | Melbourne, AU | Zurich, CH

 +84.28.6268.2523 / 6268.2524

 info@daviteq.com

www.iot.daviteq.com

Created date: Jul-03-2024

Updated date: Nov-04-2024

2/4

A WIRELESS RS485 NETWORK then CONNECT TO GLOBIOTS

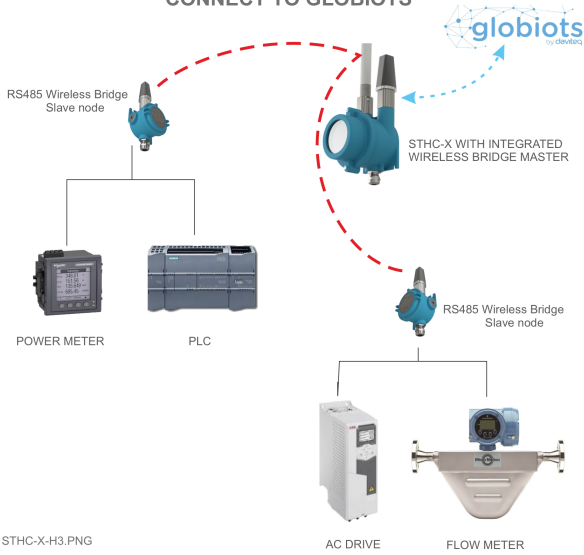

CONNECT WIRELESS SENSOR NETWORK TO GLOBIOTS OR ANY IOT PLATFORM

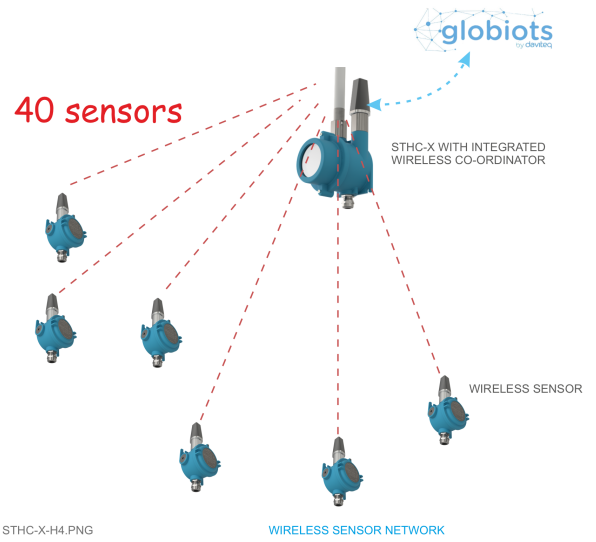

HIGH GAIN OMNI ANTENNA 3DBI & 6DBI

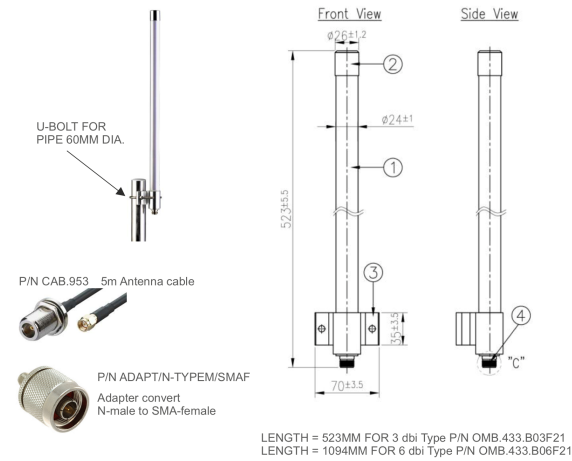

DIMENSION DRAWING STHC-X

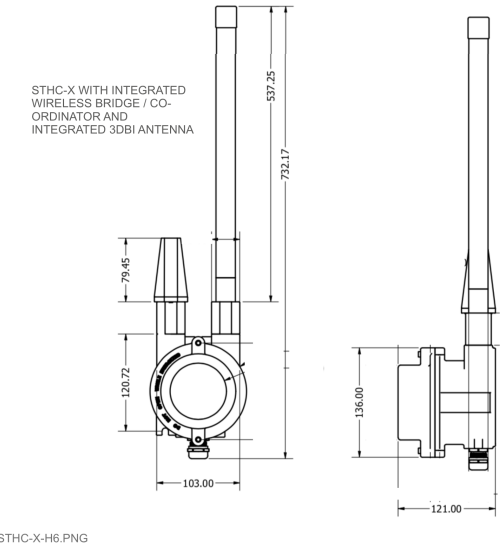

SIMPLE WIRING DIAGRAM

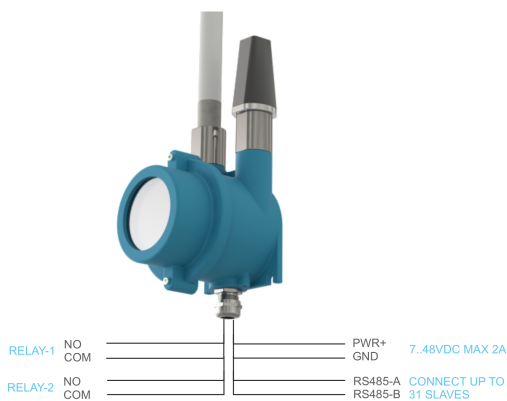

USB-RS485 CONFIGURATION CABLE



Ordering Information

ITEM CODE	DESCRIPTIONS
STHC-X-ISG02DB	iConnector 3G Dual Band, Ex d, external GSM antenna 2.3 dbi N-male, RS485/ModbusRTU
STHC-X-ISG02	iConnector 3G Penta Band, Ex d, external GSM antenna 2.3 dbi N-male, RS485/ModbusRTU
STHC-X-ISGWF	iConnector WiFi, Ex d, external WiFi antenna 4.48 dbi N-male, RS485/ModbusRTU
STHC-X-ISGETH	iConnector Ethernet, Ex d, RS485/ModbusRTU
WITH INTEGRATED WIRELESS BRIDGE	
STHC-X-ISG02DB-WS433-BLEX-RS485-M3	iConnector 3G Dual Band*, Ex d, external GSM antenna 2.3 dbi N-male, RS485/ModbusRTU with built-in wireless bridge, master RS485, external antenna 3dbi with 5m RF cable
STHC-X-ISG02-WS433-BLEX-RS485-M3	iConnector 3G Penta Band*, Ex d, external GSM antenna 2.3 dbi N-male, RS485/ModbusRTU with built-in wireless bridge, master RS485, external antenna 3dbi with 5m RF cable
STHC-X-ISGWF-WS433-BLEX-RS485-M3	iConnector WiFi*, Ex d, external WiFi antenna 4.48 dbi N-male, RS485/ModbusRTU with built-in wireless bridge, master RS485, external antenna 3dbi with 5m RF cable
WITH INTEGRATED WIRELESS CO-ORDINATOR	
STHC-X-ISG02DB-WS433-CLEX-04	iConnector 3G Dual Band*, Ex d, external GSM antenna 2.3 dbi N-male, RS485/ModbusRTU with built-in wireless co-ordinator, external antenna 3dbi with 5m RF cable
STHC-X-ISG02-WS433-CLEX-04	iConnector 3G Penta Band*, Ex d, external GSM antenna 2.3 dbi N-male, RS485/ModbusRTU with built-in wireless co-ordinator, external antenna 3dbi with 5m RF cable
STHC-X-ISGWF-WS433-CLEX-04	iConnector WiFi*, Ex d, external WiFi antenna 4.48 dbi N-male, RS485/ModbusRTU with built-in wireless co-ordinator, external antenna 3dbi with 5m RF cable
ACCESSORIES FOR CELLULAR IOT GATEWAY (ICONNECTOR)	
SIMMOBI-3G	Mobifone DATA sim card, with sms (receive only), sending sms is in additional cost (for Vietnam only)
SIMMOBI-10K-01Y	12-month Data plan of Mobifone sim card, unlimited data, GPRS/EDGE/UMTS/HSPA (Vietnam only)
OPTIONAL ANTENNA & ITS ACCESSORIES	
OMB.433.B03F21	433MHz 3dBi OMNI antenna, IP65, N-female, L=523mm, c/w Male-Male N-Adapter P/N 26-8009 (excluded cable)
OMB.433.B06F21	433MHz 3dBi OMNI antenna, IP65, N-female, L=523mm, c/w Male-Male N-Adapter P/N 26-8009 (excluded cable)
CAB.953	Low lost antenna cable, 5m, N-female and SMA-male
ADAPT/N-TYPEM/SMAF	N-male to SMA-Female adapter
OTHER ACCESSORIES	
RS485-FM12-USB-1	RS485/USB multi-purpose Configuration cable** with connector m12 male, female and flying leads, with Power adapter 12VDC/2.0A
NOTES	* Order RS485-FM12-USB-1 to off-line configure iConnector, wireless bridge and co-ordinator

DAVITEQ TECHNOLOGIES INC

📍 Ho Chi Minh City, VN | Koblenz, DE | Melbourne, AU | Zurich, CH

☎️ +84.28.6268.2523 / 6268.2524

✉️ info@daviteq.com

www.iot.daviteq.com

Created date: Jul-03-2024

Updated date: Nov-04-2024

4/4