

LoRaWAN Precision Fuel Level Sensor



Smart Transportation, Smart Agriculture, Smart Building, Smart Energy, Smart Facility, Smart Factory, Smart Farm

SKU: WSLRW-CAP10

LoRaWAN PRECISION FUEL LEVEL SENSOR WSLRW-CAP10

LoRaWAN



WSLRW-CAP10-H1.JPG



WSLRW-CAP10 is a LoRaWAN fuel level sensor that utilizes the 10-year experience of Daviteq in digital capacitance measuring technique. It delivers high accuracy and stability with 0.1% of span. Ultra-low power design and smart firmware allow the complete Wireless and Sensor package to run on 2 x AA battery 1.5V for 2-5 years with 15 minutes updates. The sensor will transmit data in kilo-meters distance to LoRaWAN gateway, any brands on the market.

Typical Applications: Monitoring fuel level and fuel consumption in fuel tanks of Genset, Boiler, Heavy equipment or machinery...

Applications

Energy Monitoring, Fuel Monitoring, Process Monitoring, Smart Irrigation, Vehicle Tracking

Notes For Applications

- Monitoring fuel level and fuel consumption in fuel tanks of Genset, Boiler, Heavy equipment or machinery...
- Fuel management for Building, Factory, Construction Site, Remote Sites, BTS Tower...
- Applicable for many kinds of fluids: diesel, bio-diesel, vegetable oil, or any low viscosity non-conductive liquids
- NOT be used with other flammable fluid such as Gasoline, Alcohol, Ethanol, Acetone, Toluene or other solvents.



LoRaWAN communication

LoRaWAN communication standard to allow sensor connect to any LoRaWAN Gateway on the market



5-Year battery

Ultra-low power sensing technology from Daviteq with Ultra-low power wireless technology allow the sensor can last up to 5 years with 02 x AA batteries



High Precision 0.1%

Diesel, bio-diesel, vegetable oil, or any low viscosity non-conductive liquids



Easy to Install

Smart design for easy installation & maximum protection

Fuel management for Building, Factory,...

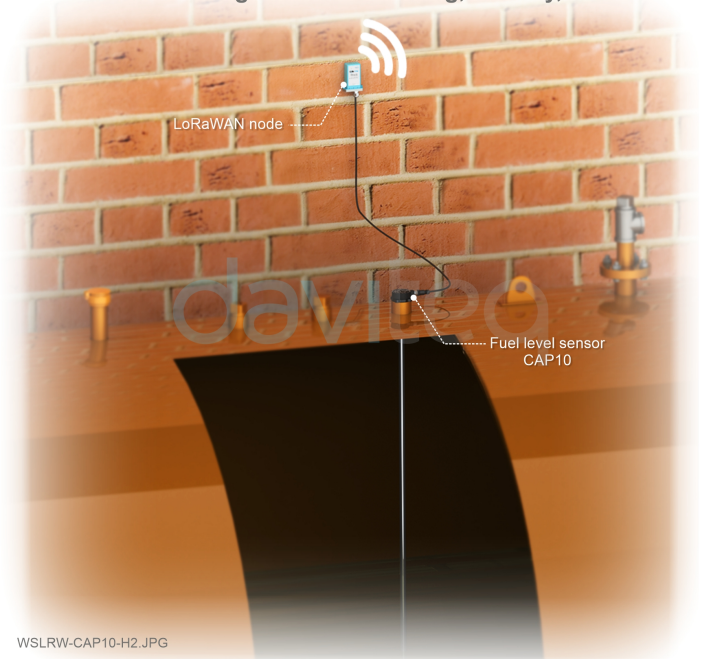

WSLRW-CAP10-H2.JPG

DAVITEQ TECHNOLOGIES INC

Ho Chi Minh City, VN | Koblenz, DE | Melbourne, AU | Zurich, CH

+84.28.6268.2523 / 6268.2524

info@daviteq.com

www.iot.daviteq.com

Created date: Dec-21-2022

Updated date: Sep-04-2024

1/4

Specification

SENSOR PROBE	
Measurement fluids	Diesel (Standard), please contact us for Bio-Diesel, Vegetable Oil, or Non-conductive and low-viscosity fluid etc.
Measurement Range (mm)	Standard Range: 700, 1000, 1500, can be extended up to 3000
Accuracy/ Resolution/ Repeatability	±0.1% of span/ 0.1%/ ±0.1% of span
Thermal drift	< +0.03% of span per 10°C
Connector	M12 male, 4-pin, Coding A
Sensor MTBF	More than 10 years
Sensor wetted materials	Aluminum and engineering plastic
Operating Temperature & Humidity Range	-20~85°C, 0~100% RH
Sensor rating	IP67, outdoor
Certification	CE-Marking per EN61236-1 (with test report)
Standard accessories	Filter footer, flange, gasket, o-ring, self-tapping screws
COMMUNICATION	
SF Factors	SF7~SF12
Antenna	Internal Antenna 2.0 dBi
Battery	02 x AA size 1.5VDC, battery not included
RF Frequency and Power	860~930MHz, 14~20 dBm, configurable for zones: EU868, IN865, RU864, KR920, AS923, AU915, US915
Protocol	LoRaWAN, class A
Data sending modes	Interval time and when alarm occurred
RF Module complies to	ETSI EN 300 220, EN 303 204 (Europe) FCC CFR47 Part15 (US), ARIB STD-T108 (Japan)
Working temperature	-40~60°C (using Energizer® Lithium Ultimate AA battery)
Dimensions and Net-weight	H140xW73xD42, 250g (LoRaWAN Device only)
Housing	Polycarbonate and Aluminum (wall mount bracket included), IP67
Sensor cable	2m sensor cable with M12-male connector

DAVITEQ TECHNOLOGIES INC

Ho Chi Minh City, VN | Koblenz, DE | Melbourne, AU | Zurich, CH

+84.28.6268.2523 / 6268.2524

info@daviteq.com

www.iot.daviteq.com

Created date: Dec-21-2022

Updated date: Sep-04-2024

2/4

Monitoring fuel level and fuel consumption in fuel tanks of Genset, Boiler, ...

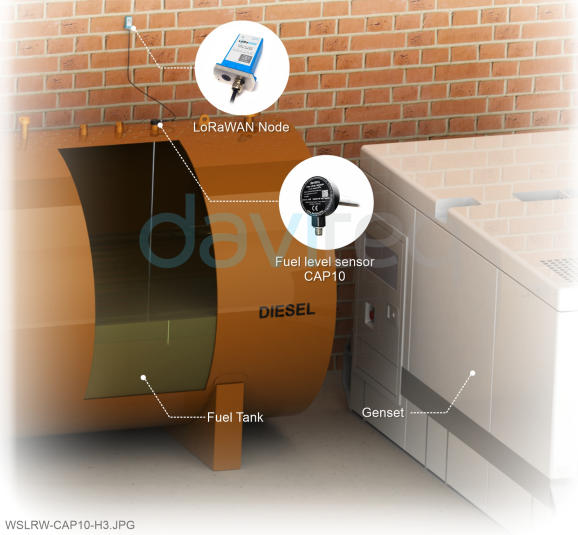

WSLRW-CAP10-H3.JPG

LoRaWAN NETWORK

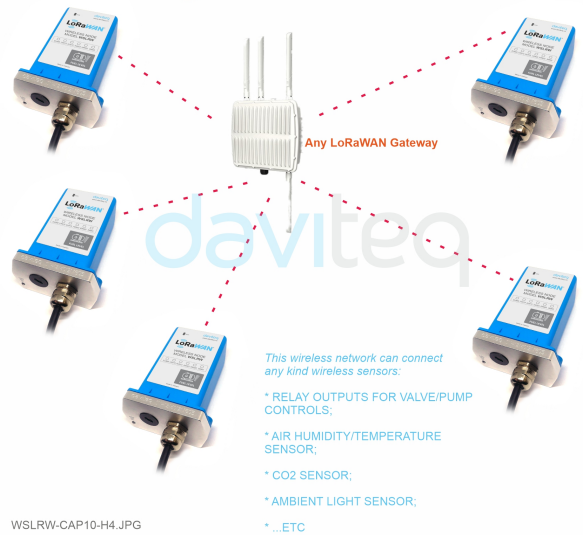

WSLRW-CAP10-H4.JPG

Smart filtered footer for stable measuring

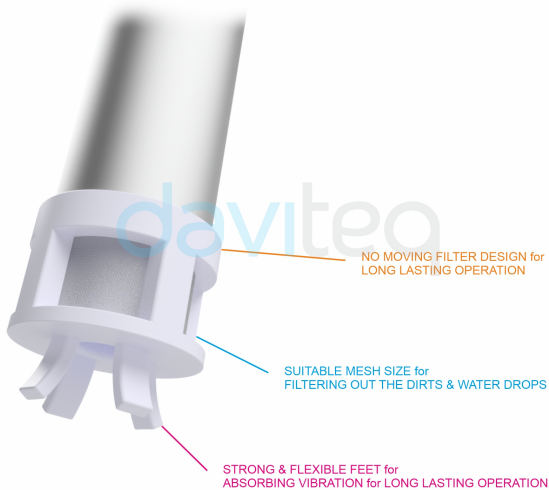

WSLRW-CAP10-H5.JPG

PulseCAP10 Package includes



WSLRW-CAP10-H6.JPG

DIMENSION DRAWING OF WIRELESS NODE (Unit: mm)

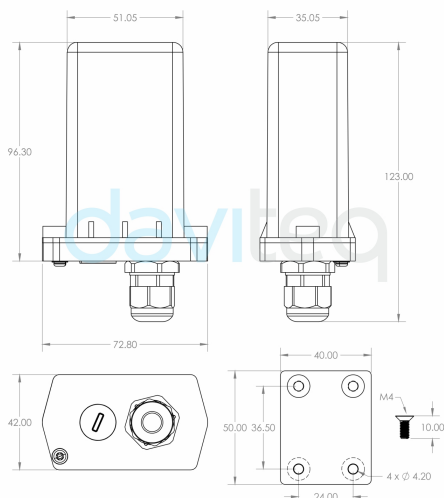

WSLRW-CAP10-H7.JPG

DIMENSION DRAWING OF FUEL SENSOR (Unit: mm)

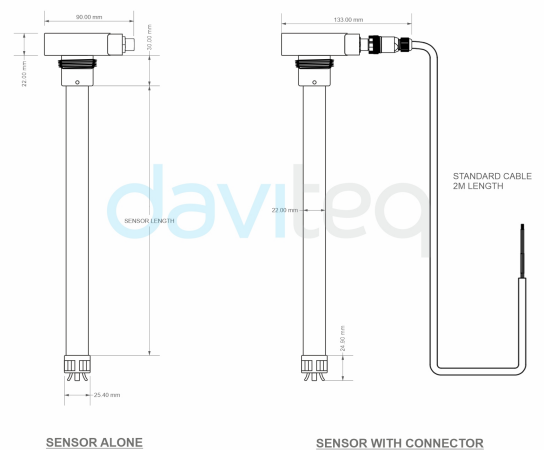

WSLRW-CAP10-H8.JPG

DAVITEQ TECHNOLOGIES INC

Ordering Information

ITEM CODE	DESCRIPTIONS
WSLRW-CAP10-1500	LORAWAN HIGH PRECISION CAPACITANCE FUEL LEVEL SENSOR FOR DIESEL OIL, VEGETABLE OIL, LUBRICANT, 1500MM, FIELD CUTTABLE, INTERNAL ANTENNA, TYPE AA BATTERY 1.5VDC, IP67, 860-930MHz
TTL-LRW-USB-01	CONFIGURATION CABLE FOR LORAWAN OR SIGFOX SENSOR, TTL, USB
CAP10PROEXT0700	CAP10 PROBE EXTENSION LENGTH 700 MM
CAP10PROEXT1000	CAP10 PROBE EXTENSION LENGTH 1000 MM
CAP10PROEXT1500	CAP10 PROBE EXTENSION LENGTH 1500 MM

DAVITEQ TECHNOLOGIES INC

 Ho Chi Minh City, VN | Koblenz, DE | Melbourne, AU | Zurich, CH

 +84.28.6268.2523 / 6268.2524

 info@daviteq.com

www.iot.daviteq.com

Created date: Dec-21-2022

Updated date: Sep-04-2024

4/4