

LoRaWAN Ultrasonic Liquid Level Sensor



Smart Agriculture, Smart Building, Smart City, Smart Facility, Smart Farm, Smart Factory, Smart Transportation, Smart Utilities

SKU: WSLRW-ULC

LoRaWAN ULTRASONIC LEVEL SENSOR WSLRW-ULC



WSLRW-ULC-H1.PNG



WSLRW-ULC is LoRaWAN Ultrasonic Level Sensor to measure the water level. This level sensor utilises the ultrasonic technology to measure the surface of liquid, the principle is to measure the time of flight of the ultrasound pulse in the air environment. The ultrasound pulse will be ejected from ultrasonic transducer, go thru the air and reaching the surface of liquid, then reflected back to the ultrasonic transducer, the measuring circuit will measure the time of flight of the Pulse then calculate the distance from transducer to the surface. With Ultra-low Power design and smart firmware allow the sensor can last up to 10 years with 02 x AA-type batteries (depends on configuration). The sensor will transmit data in kilo-meters distance to LoRaWAN gateway, any brand on the market.

Applications

Flood Monitoring, Level Monitoring, Process Monitoring, Safety Monitoring, Smart Irrigation, Infrastructure Monitoring

Notes For Applications

Non-Contact Measurement: Reduce wear and maintenance. Wide Range of Applications: Suitable for fluids, pastes, sludge, and bulk materials in harsh environment. Density and Humidity Insensitivity: Don't affect by humidity and density. Versatility: Used in oil and gas, chemical processing, water treatment, and food industries. Height Limitations: Best for small and medium liquid tanks. Medium conditions: Consider foaming liquids, turbulence, and viscosity.



LoRaWAN communication

LoRaWAN communication standard to allow sensor connect to any LoRaWAN Gateway on the market.



10-Year battery

Ultra-low power sensing technology from Daviteq with Ultra-low power wireless technology allow the sensor can last up to 10 years with 02 x AA type batteries.



High Accuracy & Stable

Advanced ultrasonic sensor with digital signal processing to deliver high accuracy and stable measurement of level or distance for liquid surface



IP68 Outdoor

IP68 design for both Indoor and Outdoor applications

DETECT WATER LEVEL ON THE CULVERT, RIVER,...



WSLRW-ULC-H2.PNG

DAVITEQ TECHNOLOGIES INC

Ho Chi Minh City, VN | Koblenz, DE | Melbourne, AU | Zurich, CH

+84.28.6268.2523 / 6268.2524

info@daviteq.com

www.iot.daviteq.com

Created date: Dec-21-2022

Updated date: Mar-25-2026

Specification

Sensor	Ultrasonic sensor
Measurement range	250~5500mm (Non-flat surface will give shorter range in actual condition)
Resolution	±5.0mm
Accuracy	±10mm + S*0.3% (with S is the measured value)
Sensor sampling rate	configurable from 10s up to 3600s
Alarm setting	setting the alarm threshold for calculated value
COMMUNICATION	
SF factors	SF7~SF12
Antenna	Internal Antenna 2.0dbi
Battery	02 x AA size 1.5VDC, battery not included
RF Frequency and Power	860~930MHz, 14~20dBm, configurable for zones: EU868, IN865, RU864, KR920, AS923, AU915, US915
Protocol	LoRaWAN® Class A
Data sending modes	Interval time and when alarm occurred
Configuration	via downlink or offline cable (software is free)
RF Module complies to	ETSI EN 300 220, EN 303 204 (Europe) FCC CFR47 Part15 (US), ARIB STD-T108 (Japan)
Working temperature	-15~60°C (with AA L91 Energizer®)
Dimensions	H180xW50xD40
Net-weight	250g
Housing	Polycarbonate & POM plastic, IP68

DAVITEQ TECHNOLOGIES INC

 Ho Chi Minh City, VN | Koblenz, DE | Melbourne, AU | Zurich, CH

 +84.28.6268.2523 / 6268.2524

 info@daviteq.com

www.iot.daviteq.com

Created date: Dec-21-2022

Updated date: Mar-25-2026

LEVEL SENSOR INSTALLED IN WATER TANK



WSLRW-ULC-H3.PNG

LoRaWAN NETWORK



WSLRW-ULC-H4.PNG

- This wireless network can connect any kind wireless sensors:*
- * RELAY OUTPUTS FOR VALVE/PUMP CONTROLS;
 - * AIR HUMIDITY/TEMPERATURE SENSOR;
 - * CO2 SENSOR;
 - * AMBIENT LIGHT SENSOR;
 - * ...ETC

PACKAGE INCLUDES



WSLRW-ULC-H5.PNG

DIMENSION DRAWING OF WIRELESS SENSOR

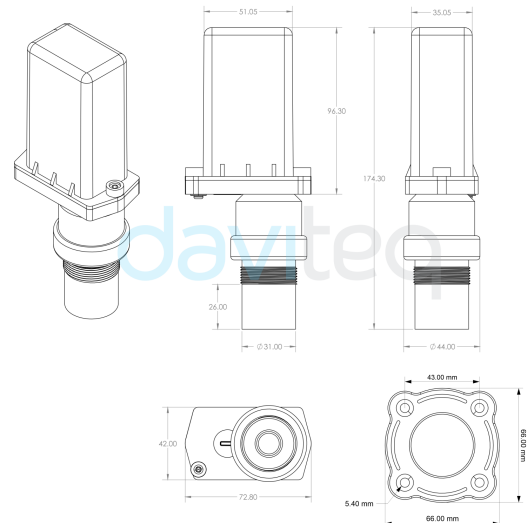

WSLRW-ULC-H6.PNG

RECOMMENDED BATTERIES

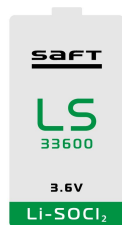

LS 33600
Lithium battery
-60~85°C working temperature
Low self-discharge rate
17000 mAh capacity

POWERED BY PRIMARY BATTERY

LORAWAN EXD AMBIENT HUMIDITY AND TEMPERATURE SENSOR WSLRWEX-ATH



STANDARD PRODUCT PACKAGE

DAVITEQ TECHNOLOGIES INC

Ho Chi Minh City, VN | Koblenz, DE | Melbourne, AU | Zurich, CH

+84.28.6268.2523 / 6268.2524

info@daviteq.com

www.iot.daviteq.com

Created date: Dec-21-2022

Updated date: Mar-25-2026

Ordering Information

ITEM CODE	DESCRIPTIONS
WSLRW-ULC-01	LoRaWan Ultrasonic Level Sensor for General Level/Distance Measurement, 25-600cms, internal antenna, Type AA battery 1.5VDC, IP67, 860-930MHz for all regions

DAVITEQ TECHNOLOGIES INC

 Ho Chi Minh City, VN | Koblenz, DE | Melbourne, AU | Zurich, CH

 +84.28.6268.2523 / 6268.2524

 info@daviteq.com

www.iot.daviteq.com

Created date: Dec-21-2022

Updated date: Mar-25-2026