

# LoRaWAN Oval Gear PD Flow Meter



SKU: WSLRWAL-TF

## LoRaWAN PD FLOW METER WSLRWAL-TF

LoRaWAN



WSLRWAL-TF-H1.JPG

Safe Zone

Hazardous Zones

WSLRWAL-TF is a PD Oval gear liquid flow meter with LoRaWAN connection. Designed to produce high accuracy, and a wide turn-down range. This flowmeter is used to measure the flow of liquids such as Diesel, chemicals... The device works with a C-size battery for 5-10 years. Allows connection to any LoRaWAN Gateway on the market, and fully supports all LoRaWAN frequency bands in the World.

### Applications

### Notes For Applications

- High Accuracy**  
Up to 0.2% of reading after Linearization
- For Low and High Viscosity**  
Can be used for Diesel, Lubricants, and Chemicals...
- No Straight pipe run required**  
Saving installation space
- LoRaWAN Connectivity**  
Support all LoRaWAN frequency bands in the World

### DIMENSION DRAWING FOR DN80/PN16 (Unit: mm)

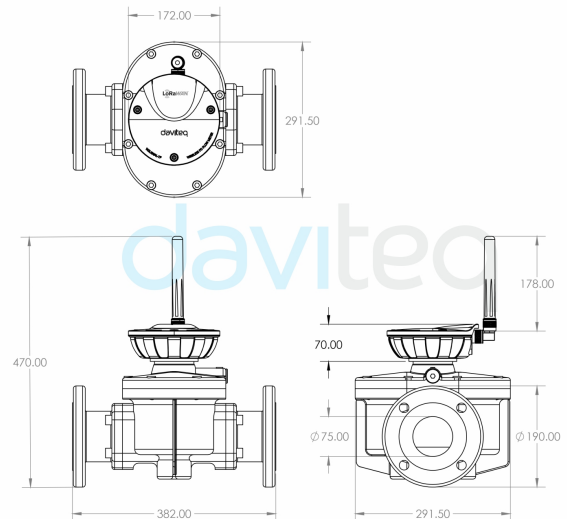

WSLRWAL-TF-H2.JPG

## DAVITEQ TECHNOLOGIES INC

Ho Chi Minh City, VN | Koblenz, DE | Melbourne, AU | Zurich, CH

+84.28.6268.2523 / 6268.2524

info@daviteq.com

www.iot.daviteq.com

Created date: May-27-2024

Updated date: Aug-28-2024

1/3

## Specification

Measuring technology	Oval gear Positive Displacement measurement method
Measuring range	0.0005~150 m <sup>3</sup> /h
Sizes	1/8"~4"
Linearity	±1.0%, 0.5%, 0.2% of measured value
Repeatability	±0.03% of measured value
Working temperature range	-20~120°C
Body material	Stainless steel or Aluminum
Working pressure	68 barg max
Connection	Threads, Flange
Communication	LoRaWAN Class A, V1.0.3
Data rate	250~5470b/s
Antenna	External antenna
RF power and frequency	860~930 MHz, 14~20 dBm, configurable for zones: EU868, IN865, RU864, KR920, AS923, AS923-2, AU915, US915
Mode of sending data	periodic interval, or when the state of input changes, and is activated by magnetic key.
RF module compliant	ETSI EN 300 220, EN 303 204 (Europe) FCC CFR47 Part15 (USA), ARIB STD-T108 (Japan)
Configuration	Via Downlink or via USB cable (PC software provided free of charge)
Battery	1 x 3.6V type C LiSOCl <sub>2</sub> battery (recommended SAFT LS26500). Batteries are not included with the device.
Electronic housing	Aluminum alloy, powder coated, IP66
Area of application	Safe zone
Working environment temperature	-40~85°C (For use with SAFT LS26500)
Dimensions	see dimension drawing for corresponding sizes
Net weight	see dimension drawing for corresponding sizes

### DAVITEQ TECHNOLOGIES INC

 Ho Chi Minh City, VN | Koblenz, DE | Melbourne, AU | Zurich, CH

 +84.28.6268.2523 / 6268.2524

 info@daviteq.com

[www.iot.daviteq.com](http://www.iot.daviteq.com)

Created date: May-27-2024

Updated date: Aug-28-2024

2/3

## Ordering Information

WSLRWAL-TF-050A001-261RS	LoRaWAN Oval Gear PD Flow Meter, external antenna, IP66, DN50 2", 1.8-30 m3/h, 0.5% accuracy, Aluminum Body, PPS rotor, Viton, -15..120 oC, 10 barg, PN16 flanges
WSLRWAL-TF-080E001-261RS	LoRaWAN Oval Gear PD Flow Meter, external antenna, IP66, DN80 3", 3.0-60 m3/h, 0.5% accuracy, Aluminum Body, PPS rotor, Viton, -15..120 oC, 10 barg, PN16 flanges
WSLRWAL-TF-100A001-261RS	LoRaWAN Oval Gear PD Flow Meter, external antenna, IP66, DN100 4", 4.5-90 m3/h, 0.5% accuracy, Aluminum Body, PPS rotor, Viton, -15..120 oC, 10 barg, PN16 flanges
WSLRWAL-TF-100E001-261RS	LoRaWAN Oval Gear PD Flow Meter, external antenna, IP66, DN100 4", 9.0-150 m3/h, 0.5% accuracy, Aluminum Body, PPS rotor, Viton, -15..120 oC, 10 barg, PN16 flanges

### DAVITEQ TECHNOLOGIES INC

 Ho Chi Minh City, VN | Koblenz, DE | Melbourne, AU | Zurich, CH

 +84.28.6268.2523 / 6268.2524

 info@daviteq.com

[www.iot.daviteq.com](http://www.iot.daviteq.com)

Created date: May-27-2024

Updated date: Aug-28-2024

3/3