

Sigfox Gas Detecting Sensor



Smart Agriculture, Smart Building, Smart City, Smart Facility, Smart Factory, Smart Farm, Smart Healthcare, Smart Retail, Smart Transportation

SKU: WSSFC-G4

Safe Zone

Hazardous Zones

SIGFOX-READY GAS SENSOR WSSFC-G4



WSSFC-G4-H1.JPG



WSSFC-G4 is a Sigfox-ready electrochemical-type gas sensor with a high sensitivity to low concentrations of detected gas, high selectivity, and a stable baseline. The device supports different types of gas such as CO, NO, NO₂, H₂S, NH₃, O₂, O₃, SO₂, Cl₂, HCHO... With ultra-low-power design and smart firmware allow the complete Wireless and Sensor package run on 2 x AA battery 1.5V for 5-10 years (depend on configuration). It supports all regions of the Sigfox network over the World RC1, RC2, RC3, RC4, RC5, RC6, and RC7. Typical Applications are Gas, toxic gas detecting, air quality monitoring for facility, building, pump station, HVAC...

Applications

Ambient Air Quality Monitor, Indoor Air Quality Monitor, Gas Analyzing, Warehouse Monitoring, Gas Leakage Detection

Notes For Applications

- Select the suitable sensor range to get highest accuracy v.s sensor life.
- Have life time is 1-2 years, depends on sensor type and actual operating conditions;
- Need to be calibrated regularly (6-12 months), depends on actual operating conditions;
- Check carefully the working temperature and humidity of the application;
- Use the Rain-guard of Splash-guard for outdoor installation or where water jet exist.

Sigfox-Ready
Device are best operating performance on the SIGFOX network

5-10 years battery
Ultra-low power sensing technology from Daviteq with Ultra-low power wireless technology allow the sensor can last up to 5-10 years with 02 x AA batteries

High Accuracy & Stable
Advanced electrochemical-type gas sensor technology processing to deliver high accuracy and stable measurement

Multiple choices of gas

SIGFOX-READY GAS SENSOR WSSFC-G4



WSSFC-G4-H2.JPG



DAVITEQ TECHNOLOGIES INC

Ho Chi Minh City, VN | Koblenz, DE | Melbourne, AU | Zurich, CH

+84.28.6268.2523 / 6268.2524

info@daviteq.com

www.iot.daviteq.com

Created date: Jun-03-2023

Updated date: Aug-28-2024

1/4

Specification

Select gas sensor	CO, NO, NO ₂ , H ₂ S, NH ₃ , O ₂ , O ₃ , SO ₂ , Cl ₂ , HCHO etc.
Gas sensor type and specification	List of compatible gas sensors and specification
Sensor housing/ Rating	SS316/SS304 housing with 316SS sintered filter/ for Indoor use (buy the optional accessory rain-guard for outdoor installation)
COMMUNICATION	
Sigfox zones	RC1~RC7
Antenna	Internal Antenna 2.0 dbi
Battery	02 x AA size 1.5VDC, battery not included
Data sending modes	Interval time and when alarm occurred
Configuration	via Downlink or Offline cable (software is free)
RF Module complies to	ETSI EN 300 220, EN 303 204 (Europe) FCC CFR47 Part15 (US), ARIB STD-T108 (Japan)
Working temperature	-40~60°C (with AA L91 Energizer®)
Housing/ Protection	Aluminum + Polycarbonate/ IP67
Dimension/ Net weight	H180xW73xD4/ < 400grams

DAVITEQ TECHNOLOGIES INC

 Ho Chi Minh City, VN | Koblenz, DE | Melbourne, AU | Zurich, CH

 +84.28.6268.2523 / 6268.2524

 info@daviteq.com

www.iot.daviteq.com

Created date: Jun-03-2023

Updated date: Aug-28-2024

2/4

DETECT AMMONIA GAS IN PROCESS PLANT



WSSFC-G4-H3.JPG

GAS SENSOR WITH RAIN GUARD FOR OUTDOOR INSTALLATION

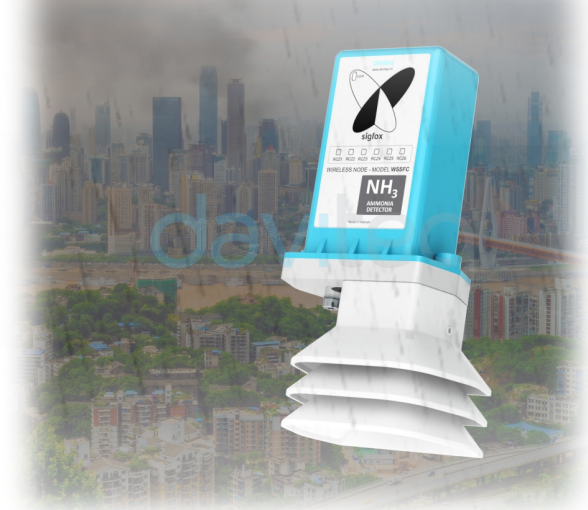

WSSFC-G4-H4.JPG

SYSTEM ARCHITECTURE

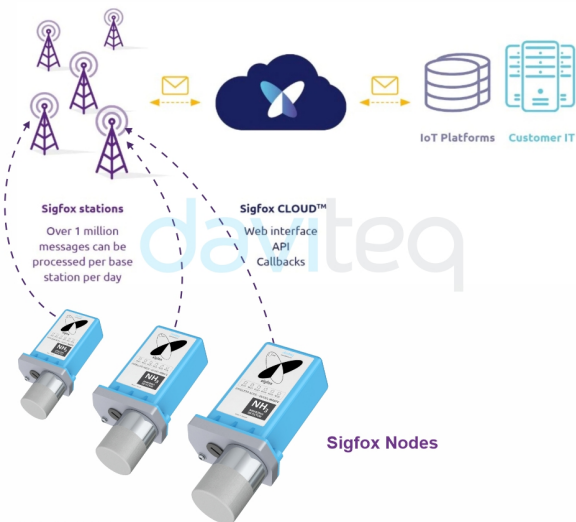

WSSFC-G4-H5.JPG

WHAT'S IN THE PACKAGE?



WSSFC-G4-H6.JPG

DIMENSION DRAWING OF WIRELESS SENSOR (Unit: mm)

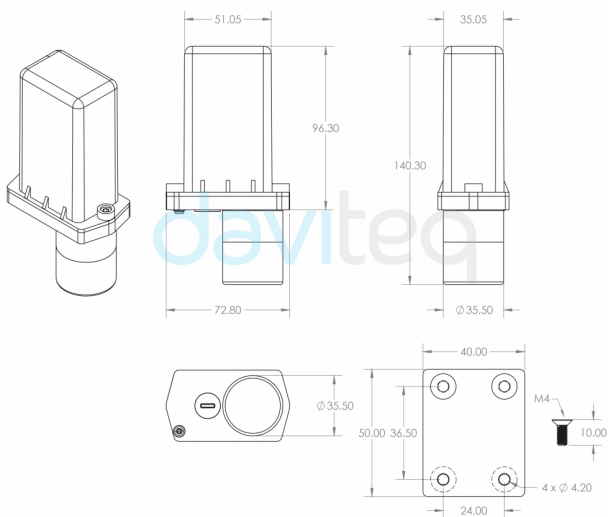

WSSFC-G4-H7.JPG

RECOMMENDED BATTERIES

E91 AA Alkaline battery



-18 .. + 60 oC working temperature
10-year shelf life
3000 mAh Capacity
Price: 1X

L91 AA Lithium battery



-40 .. + 60 oC working temperature
20-year shelf life
3500 mAh Capacity
Price: 3.5X

WSSFC-G4-H8.JPG

DAVITEQ TECHNOLOGIES INC

📍 Ho Chi Minh City, VN | Koblenz, DE | Melbourne, AU | Zurich, CH
 ☎️ +84.28.6268.2523 / 6268.2524
 ✉️ info@daviteq.com

www.iot.daviteq.com

Created date: Jun-03-2023

Updated date: Aug-28-2024

Ordering Information

ITEM CODE	DESCRIPTIONS
WSSFC-G4-CO-200-01	Sigfox-Ready Gas Detecting Sensor, Carbon Monoxide Gas CO, 0-200ppm
WSSFC-G4-H2S-50-01	Sigfox-Ready Gas Detecting Sensor, Hydrogen Sulfide Gas H ₂ S, 0-50ppm
WSSFC-G4-NH3-100-01	Sigfox-Ready Gas Detecting Sensor, Ammonia Gas NH ₃ , 0-100ppm
WSSFC-G4-Cl2-20-01	Sigfox-Ready Gas Detecting Sensor, Chlorine Gas Cl ₂ , 0-20ppm
Accessories and optional items	
ACC-G4-RAINGUARD-01	Rain guard for G4 Gas Sensor
ACC0G4-SG-01	Splash guard for G4 Gas Sensor
CALGAS-CL2-02	02-point Calibration Services for Chlorine Gas Cl ₂
CALGAS-CO-02	02-point Calibration Services for Carbon Monoxide Gas CO
CALGAS-H2S-02	02-point Calibration Services for Hydrogen Sulfide Gas H ₂ S
CALGAS-NH3-02	02-point Calibration Services for Ammonia Gas NH ₃

DAVITEQ TECHNOLOGIES INC

 Ho Chi Minh City, VN | Koblenz, DE | Melbourne, AU | Zurich, CH

 +84.28.6268.2523 / 6268.2524

 info@daviteq.com

www.iot.daviteq.com

Created date: Jun-03-2023

Updated date: Aug-28-2024

4/4