

# Sigfox Lidar People Counter



Smart Building, Smart City, Smart Facility, Smart Retail

SKU: WSSFC-LPC

Safe Zone

Hazardous Zones

## SIGFOX LIDAR PEOPLE COUNTER WSSFC-LPC



The WSSFC-LPC is a Sigfox sensor that is equipped with an advanced Lidar sensor designed to count people in two directions. It provides an accuracy rate of over 95% in people counting and is not significantly affected by temperature, humidity, RF noise, and ambient light. With an ultra-low power design and smart firmware, the wireless and sensor package can run on AA batteries (1.5V) for many years. The sensor is compatible with all regions of the Sigfox network, including RC1, RC2, RC3c, and RC4.

Typical applications of the WSSFC-LPC include people counting in public toilets, stores, shops, and other similar spaces.

### Applications

Facility Monitoring, Safety Monitoring

### Notes For Applications

- It counts one person at a time. For indoor only. Floor color must be bright;
- Gate width max 1500mm;
- Gate height from 2000 to 3500mm;
- Walking speed < 1.38 m/s (5 km/h);

WSSFC-LPC-H1.JPG



- Sigfox Ready**  
Device are best operating performance on the SIGFOX network
- High Accuracy & Stable**  
High accuracy counting by Lidar
- Distinguish people in and out**  
Smart software and built-in sensors can distinguish people from entering and leaving accurately
- 5-Year battery**  
Ultra-low power sensing technology from Daviteq with Ultra-low power wireless technology allow the sensor can operate for years with AA batteries 1.5VDC

### People Counter for Store, Shop...



WS433-LPC-H2.JPG

## DAVITEQ TECHNOLOGIES INC

Ho Chi Minh City, VN | Koblenz, DE | Melbourne, AU | Zurich, CH

+84.28.6268.2523 / 6268.2524

info@daviteq.com

www.iot.daviteq.com

Created date: Dec-21-2022

Updated date: Aug-28-2024

1/4

## Specification

Sensor technology	Lidar
Gate height	2.2~4.0m
Gate width	0.75~1.5m
Detection cone	27°
Working temperature	-40~60°C
Working humidity	0~100% RH, non-condensing
COMMUNICATION	
Sigfox zones	RC1~RC7
Functions	Sending data in interval or when alarms occur
Antenna	Internal Antenna 2.0 dbi
Configuration	via Downlink of offline USB cable (PC software is supplied at free)
Power Supply	6 x Batteries AA Type 1.5VDC (not included)
RF Module complies to	CE, FCC, ARIB
Working temperature	-40~60°C (with Lithium Ultimate AA battery)
Dimensions	H120xW80xD45
Net-weight	< 150g
Housing	Self-extinguisher ABS, Dust and vapor protection
Mounting	Ceiling mount

### DAVITEQ TECHNOLOGIES INC

 Ho Chi Minh City, VN | Koblenz, DE | Melbourne, AU | Zurich, CH

 +84.28.6268.2523 / 6268.2524

 info@daviteq.com

[www.iot.daviteq.com](http://www.iot.daviteq.com)

Created date: Dec-21-2022

Updated date: Aug-28-2024

2/4

SYSTEM ARCHITECTURE

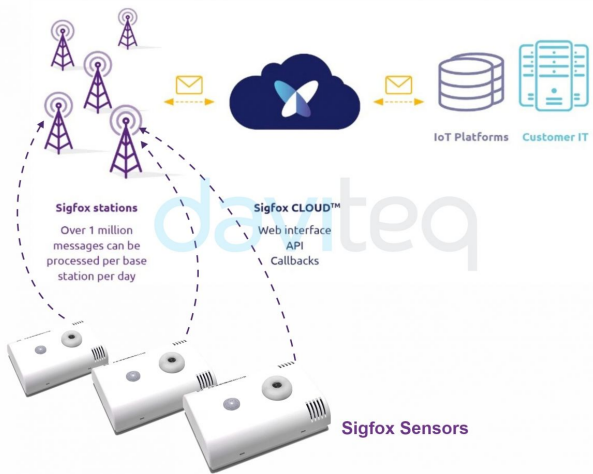

WSSFC-LPC-H3.JPG

DIMENSION DRAWING OF WIRELESS SENSOR (Unit: mm)

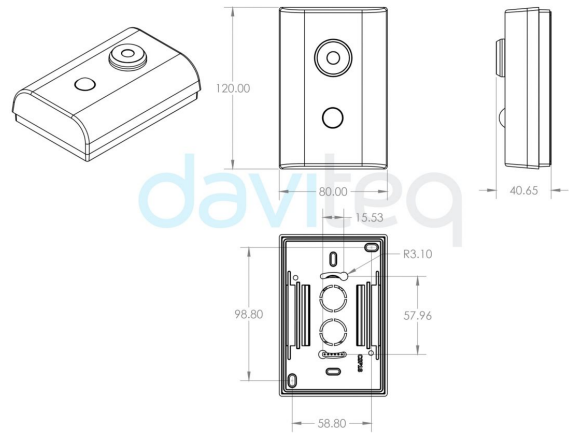

WSSFC-LPC-H4.JPG

RECOMMENDED BATTERIES

E91 AA Alkaline battery



- 18 .. + 60 oC working temperature
- 10-year shelf life
- 3000 mAh Capacity
- Price: 1X

L91 AA Lithium battery



- 40 .. + 60 oC working temperature
- 20-year shelf life
- 3500 mAh Capacity
- Price: 3.5X

WSSFC-LPC-H5.JPG

SMART AGRICULTURE / SMART FARM / ENVIRONMENTAL MONITORING



WSSFC-IO-H6.PNG

INTERNAL WIRING

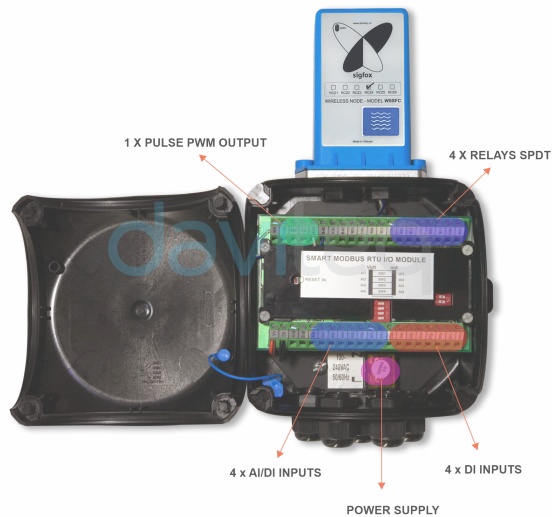

WSSFC-IO-H7.PNG

USB-RS485 CONFIGURATION CABLE



WSSFC-IO-H8.PNG

DAVITEQ TECHNOLOGIES INC

## Ordering Information

ITEM CODES	DESCRIPTIONS
WSSFC-LPC-01	Sigfox Lidar People Counter, Internal Antenna, Type AA Battery 1.5VDC, IP20, for all RC zones

### DAVITEQ TECHNOLOGIES INC

 Ho Chi Minh City, VN | Koblenz, DE | Melbourne, AU | Zurich, CH

 +84.28.6268.2523 / 6268.2524

 info@daviteq.com

[www.iot.daviteq.com](http://www.iot.daviteq.com)

Created date: Dec-21-2022

Updated date: Aug-28-2024

4/4